









Spring probe for battery



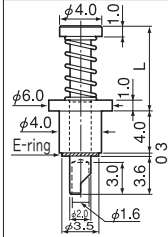
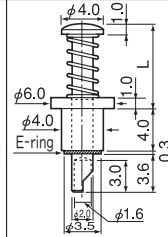
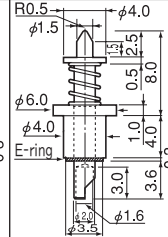
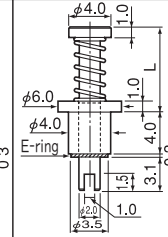

VB series (10pcs/pack)

- This is used for charging a battery, etc. and discharging.
- This can be used with inrush current.
- Two types (for fitting PC board (VB-2 series) and for fitting resin (VB-20 series)) are available.
- Material Body: Brass
 Contact part: Brass
 Spring: Stainless steel
 E-ring: Stainless steel
- Finish: Body, Contact part: Gold plating over nickel base
- Rated current: 5A
- Contact resistance: 10m Ω or less
- Durability: 10000 times or over
- Operating temperature range: - 20 to +100°C

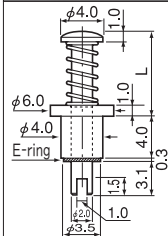
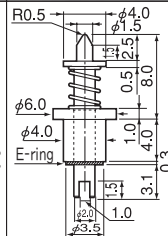
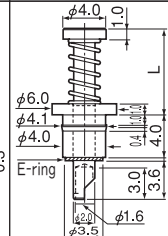
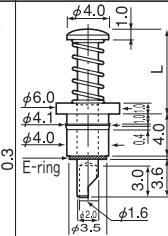
■ Part No.

			
			
Part No. L	Part No. L	Part No. L	Part No. L
VB-2-6-AA 6.0	VB-2-6-BA 6.0	VB-2-8-CA 8.0	VB-2-6-AB 6.0
VB-2-8-AA 8.0	VB-2-8-BA 8.0		VB-2-8-AB 8.0

			
			
Part No. L	Part No. L	Part No. L	Part No. L
VB-2-6-BB 6.0	VB-2-8-CB 8.0	VB-2-6-AA 6.0	VB-2-6-BA 6.0
VB-2-8-BB 8.0		VB-2-8-AA 8.0	VB-2-8-BA 8.0

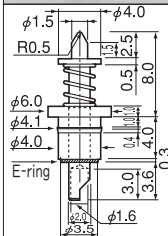
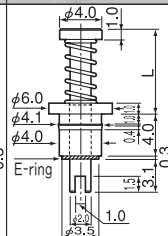
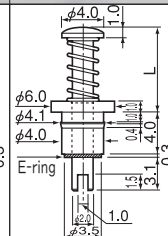
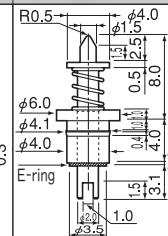
			
			
Part No. L	Part No. L	Part No. L	Part No. L
VB-20-8-CA 8.0	VB-20-6-AB 6.0	VB-20-6-BB 6.0	VB-20-8-CB 8.0
	VB-20-8-AB 8.0	VB-20-8-BB 8.0	



■ Example of usage

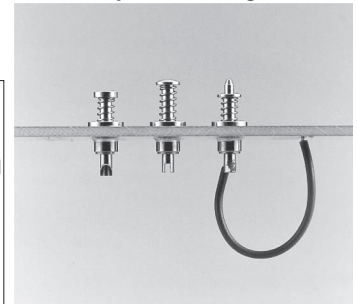

When this is fit to a PC board

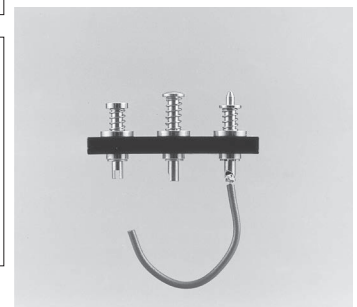

When this is fit to resin

■ Fitting hole diameter

- For fitting PC board (VB-2 series)

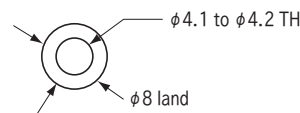

★ Do not use the land electrically. (This is for fixing.)

- For fitting resin (VB-20 series)

φ4.05 (Reference value)

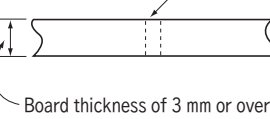

■ Operating forces

- With a stroke of 1 mm:
 VB-□-6 type: 200g
 VB-□-8 type: 200g
 VB-□-8-C□ type: 200g

■ Stroke

- VB-□-6 type: 1.5mm
 VB-□-8 type: 2.0mm
 VB-□-8-C□ type: 1.5mm

■ Fitting method

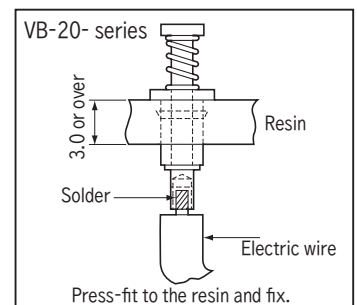
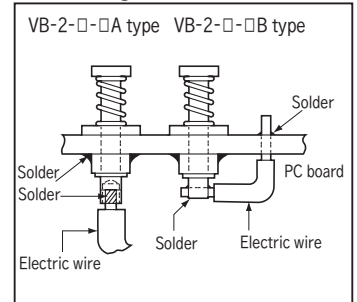

Spring probe for battery

VB series (10pcs/pack)

■ **VB-24 series**

- The specifications other than those described below are the same as VB-2, VB-20 series.
- This product can be fixed with a nut. (This product includes the nut.)
- Thickness of the board that can be fit: 1.0 mm to 3.0 mm
- Fitting hole diameter: ϕ 4.2
- Operating forces: 200g with a stroke of 1 mm
- Stroke: VB-24-6 type: 1.5mm
 VB-24-8 type: 2mm
 VB-24-8-C type: 1.5mm



■ **Example of usage**

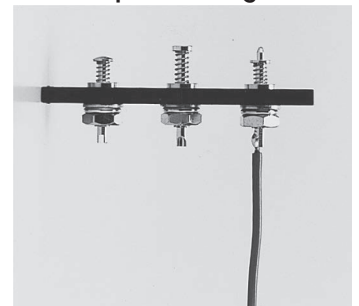

■ **Part No.**

Part No. L	Part No. L	Part No. L	Part No. L	Part No. L	Part No. L
VB-24-6-AA 6	VB-24-6-BA 6	VB-24-6-AB 6	VB-24-6-BB 6	VB-24-8-CA 6	VB-24-8-CB 6
VB-24-8-AA 8	VB-24-8-BA 8	VB-24-8-AB 8	VB-24-8-BB 8		

■ **VB-1, VB-10, VB-14 series**

- The specifications other than those described below are the same as those of VB-2, VB-20 series.
- Rated current: 3A
- Operating forces: Stroke of 1 mm: 90g
- Stroke: 1.5 mm



■ **Fitting method**

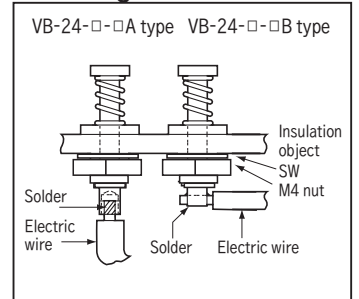

When this is fit to resin

■ **Part No.**

Part No.	Part No.	Part No.
VB-1-6-BC	VB-10-6-BC	VB-14-6-BC

■ **Fitting hole diameter**

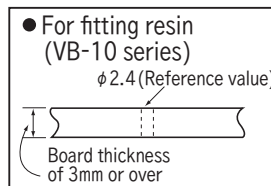
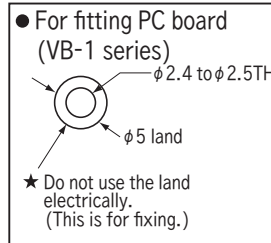

■ **Fitting method**

